

DUNCAN EXPORT MODEL DA 820-6G

CONTROL PANEL PARTS

- | REF. NO. | PART NO. | DESCRIPTION |
|----------|----------|--|
| 1. | KM 326 | 4600 Repeat Cycle Timer (240/220V) |
| 2. | KM 325 | 4300 Fixed Interval Timer (240/220V) |
| 3. | KM 324 | Power Relay (240/220V) |
| 4. | KE 314 | #8-32 X 1/2" Machine Screw |
| 5. | KE 322 | #8 Star Washer |
| 6. | KE 333 | #8-32 Hex Nut |
| 7. | KM 362 | #1 x 5-1/2" Fiberglass Sleeving |
| 8. | KM 342 | 820, 1020/29 Cord Strain Relief |
| 9. | KE 307 | #8-32 x 1-1/4" Machine Screw |
| 10. | KE 329 | #8-32 Hex Nut w/Washer |
| 11. | KE 086 | 2 Pole Terminal Strip |
| 12. | KC 309 | Standard Bus Bar Assembly |
| 13. | KC 319 | U-Terminal Assembly |
| 14. | KE 334 | #10-32 Hex Nut w/Washer |
| 15. | KE 060 | Insulator |
| 16. | KM 306 | Lid Safety Switch |
| 17. | KM 363 | Lid Switch Mounting Kit |
| 18. | KE 315 | #10-32 x 1/2" Tamperproof Screw |
| 19. | KM 336 | 820 Power Supply Cord (A,E,F,& S Models) |
| 20. | KM 300 | Infinite Switch w/Pal Nut (240V/220V) |
| 21. | KM 362 | Capacitor Assembly #2 |
| 22. | KC 167 | 6" (15 cm) Connecting Wire, 16 Gauge |
| 23. | KC 171 | 10,6,6 Wire Combo, 16 Gauge |
| 24. | KC 144 | 14" (15 cm) Connecting wire, 16 Gauge |
| 25. | KC 131 | 14" (36 cm) Connecting Wire, 16 Gauge |
| 26. | KC 191 | Pilot Light Assembly (820) |
| 27. | KC 136 | 8" (23 cm) Connecting Wire, 12 Gauge |
| 28. | KC 182 | 8" (15 cm) Connecting Wire, 12 Gauge |
| 29. | KC 178 | 14" (25 cm) Connecting Wire, 12 Gauge |
| 30. | KC 150 | 9" (23 cm) Ground Wire |
| 31. | KC 189 | 10" (25 cm) Connecting wire, 16 Gauge |
| 32. | KC 177 | 8" (15 cm) Connecting Wire, 12 Gauge |
| 33. | KC 138 | 14" (36 cm) Connecting Wire, 12 Gauge |
| 34. | KE 095 | T-Terminal Adapter |
| 35. | KM 088 | Timer Motor (50 HZ) |
| 36. | KC 173 | 6, 4 Wire Combo, 16 Gauge |
| 37. | KM 361 | 3 Position Switch |
| 38. | KC 133 | 6" (15 cm) Connecting Wire, 16 Gauge |

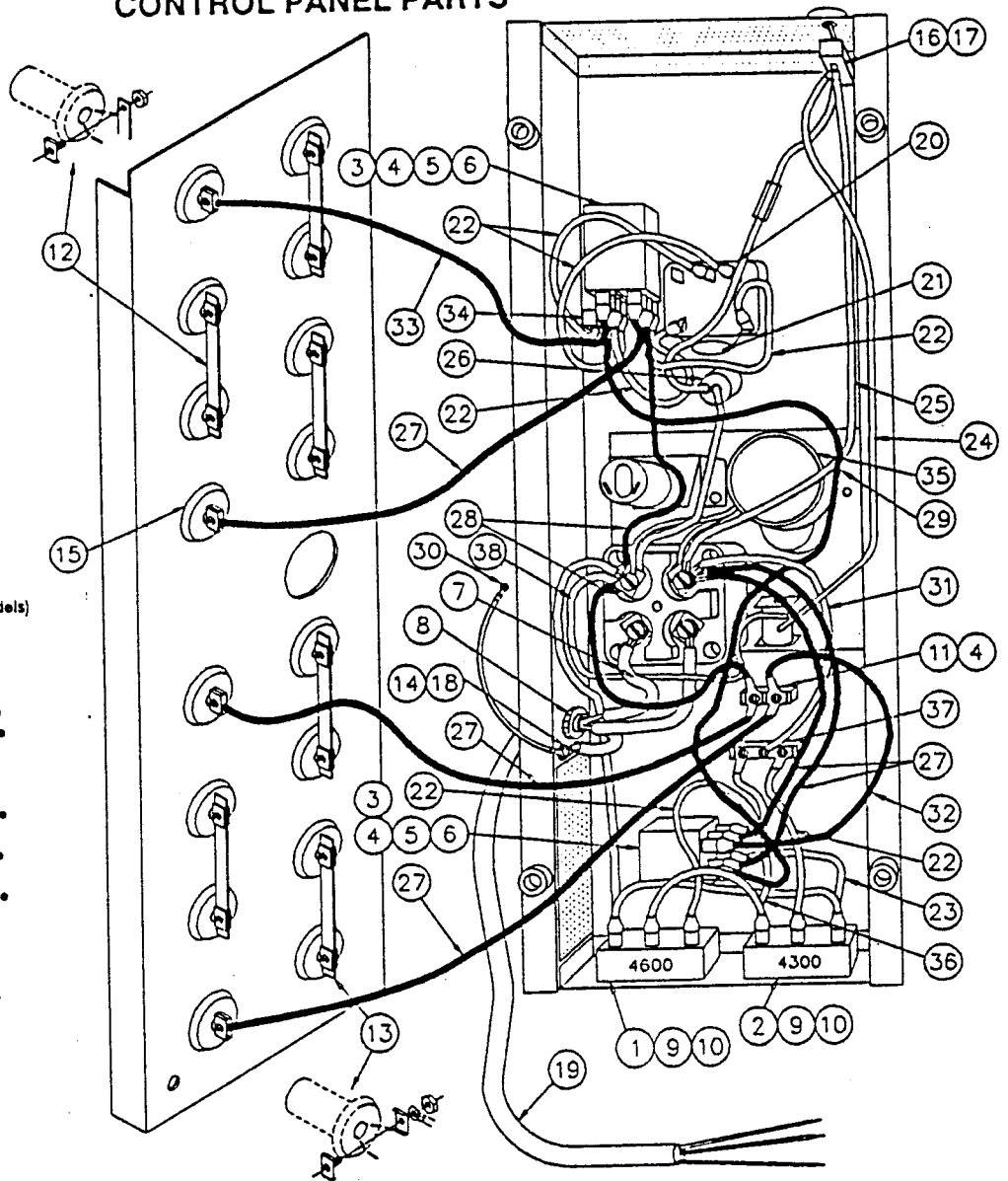

ELECTRICAL SCHEMATIC

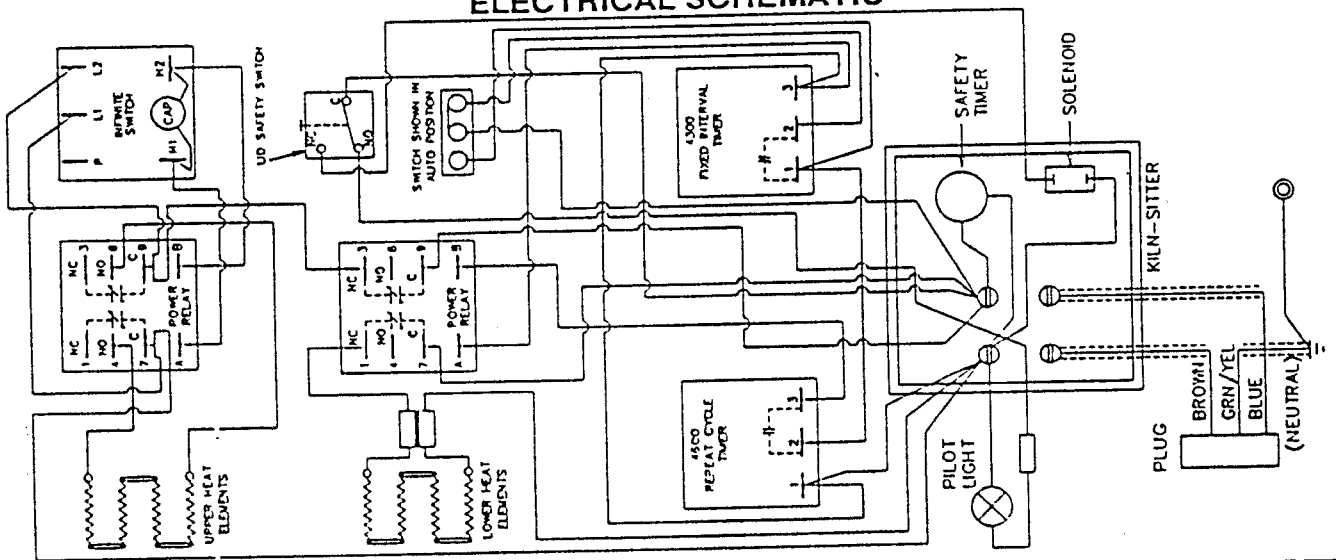

220/240VAC
50 HZ